



Metal Detection - The Basics

North America

Fortress Technology Inc.
Toronto, Canada
Phone: (416) 754-2898
Fax: (416) 754-2976
Email: fortress@fortresstechnology.com

Europe

Fortress Technology (Europe) Ltd.
Southam. UK
Phone : +44 (0)7957 540050
Fax : +44 (0)1295 770276
Email : europe@fortresstechnology.com

Contents

1. Metal Detection - The Basic Principles
 - 1.1 Theory of Operation
 - 1.2 Product Effect and Phasing
 - 1.3 Metal Free Area
 - 1.4 Sensitivity
 - 1.5 Types of Metal
 - 1.6 Shapes and Orientation

2. Testing
 - 2.1 Test Sample
 - 2.2 Frequency
 - 2.3 Procedure
 - 2.4 Records

3. Sources of Interference

4. Applications
 - 4.1 Conveyor (End of Line)
 - 4.2 Gravity
 - 4.3 Pipeline

5. Good Practice Guidelines

1. Metal Detection - The Basic Principles

1.1 Theory Of Operation

Balanced Coil

Most modern metal detectors operate on the balanced coil, full loop system.

Three coils are wrapped around the aperture through which the product passes. In the center of the enclosure is the transmitter coil that broadcasts a radio frequency signal and generates an Electro-magnetic field.

Equally spaced on either side of the transmitter coil are two receiver coils (see figures 1 and 2).

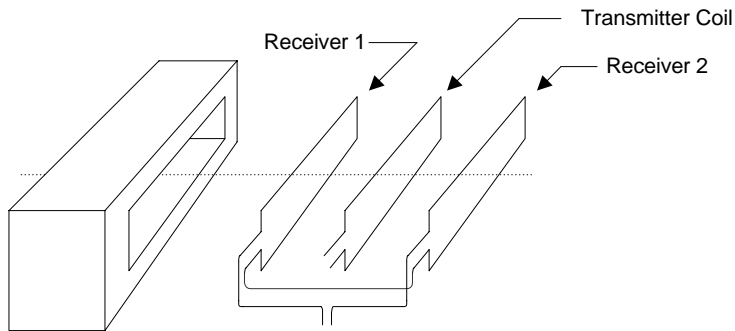

Figure 1

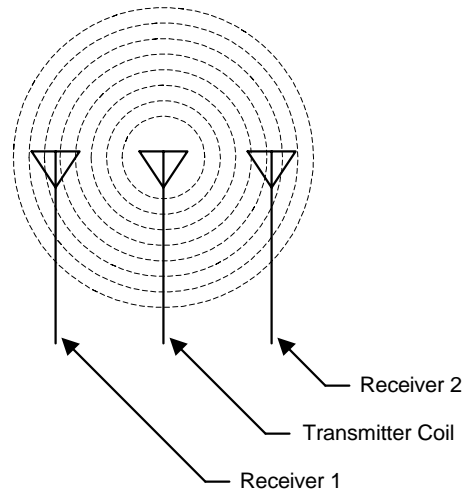

Figure 2

The field is generally trapped inside the shielded enclosure of the detector but some field escapes from the aperture on both sides of the detector. Anything that enters into this field that is either **Magnetic**, or **Electrically Conductive** will cause a disturbance in the field strength around it. All metals have either one or both of these characteristics and will be detectable if the size of the signal is large enough.

The signals from the receiving coils are connected in opposition to each other and therefore when no disturbance is occurring there will be a net signal across the coils of zero – they are balanced. This forms the electrical equivalent of a balance weigh scale (figure 3).

As metal passes through the detector the balance will be offset as the contaminant enters the aperture and again as it leaves the exit side. This disturbance is amplified and analyzed by the control electronics and a detection will occur if the sensitivity threshold has been exceeded.

Ferrous In Foil

The exception to this design occurs when a product is packaged in foil (pure aluminium). Foil lids and trays are common examples where an alternative system is required. Here the detector operates using a series of magnets and is referred to as a Ferrous in Foil detector. The drawback of this type of inspection is that Non Ferrous and Stainless contaminants can not be detected.

1.2 Product Effect and Phasing

The control electronics actually split the received signal into two separate channels: magnetic and conductive. This means there are effectively two balance scales in the detector (see figure 3). These scales continuously measure the magnetic and conductive signal component of every disturbance.

Products that are being inspected can also have one or both of these characteristics.

Product Effect

Metal detectors detect metal based on measuring electrical conductivity and magnetic permeability. Many products to be inspected inherently have one or both of these characteristics within their makeup. For example, any product which is iron enriched such as cereals, create a large magnetic signal which the detector must overcome in order to detect small pieces of metal. These are referred to as "dry" products. Conversely, products with high moisture and salt content such as bread, meat, cheese, etc. are electrically conductive and produce a conductive error signal. These are referred to as "wet" products. The table below shows typical product error signals and categorizes them as wet or dry.

The detector must remove or reduce this "product effect" in order to identify a metal contaminant. Most modern detectors will have some form of automatic calibration to do this - it is often referred to a phasing .

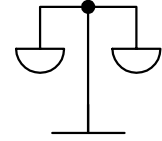

Conductive Scale

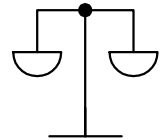

Magnetic Scale

Figure 3

Typical 'Wet' Products	Typical 'Dry' Products
<p><u>Food:</u> Meat, Cheese, Bread and Bakery Products, Fish, Dairy Products, Salads</p> <p><u>Packaging:</u> Metallized Films</p> <p><u>Other:</u> Plastic and Rubber products with high carbon black content</p>	<p><u>Food:</u> Cereal, Crackers, Flour and powders, Biscuits, Frozen Food Products (< 10 Degrees C), Peanut Butter and Margarine (Vegetable oil is not conductive)</p> <p><u>Other:</u> Wood Products, Plastics and Rubber (Products with high carbon black content may be considered 'wet'), Textiles, Paper Products</p>

1.3 Metal Free Area

The Electro-magnetic field is trapped inside the detector's enclosure (shield).

However, some field escapes out of the aperture on both sides and forms the metal free area or MFA.

Generally, the size of the practical leakage is about 1.5 times the (smaller) aperture dimension and no metal should be allowed in this area.

Large moving metal should be kept 2 x away.

Where applications demand a smaller MFA, special detectors are available which can substantially reduce the total area required.

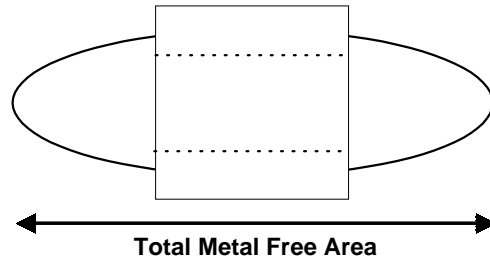

Figure 4

1.4 Sensitivity

The *theoretical* sensitivity of a given metal detector is determined by the aperture size. The smaller the aperture, the smaller the piece of metal that can be detected. The smaller dimension of rectangular apertures is used to calculate the sensitivity, although the length also contributes.

To maximise sensitivity a detector the smallest size aperture should be selected. However there are some exceptions:

- Metallised Film
- Oxygen Scavengers
- Highly Conductive product (large blocks of cheese)

Product effect, metal free area, type and orientation of contaminant and other factors can effect the *practical* sensitivity in any application.

The position in the aperture also effects the sensitivity (see figure 6).

The centerline axis is the least sensitive point and therefore this is where performance testing should take place. As metal gets closer to the sides (and coils), the signal it generates gets larger, making it easier to detect.

Regular testing of the detector should be done so that the test sphere passes close to the center of the aperture. If this is not easily done, then a consistent position should be used so that the test results will be consistent (see figure 7).

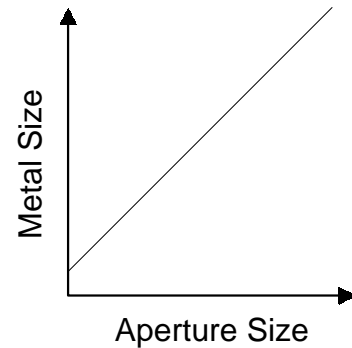

Figure 5

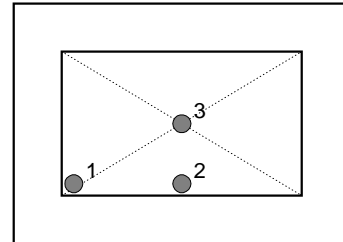

Figure 6

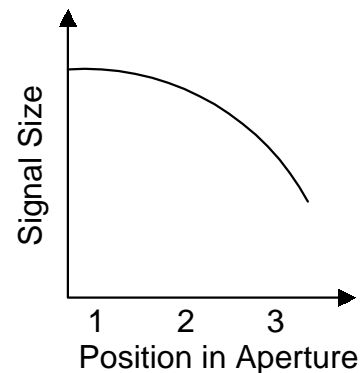

Figure 7

1.5 Types of Metal

The sensitivity of a metal detector is not the same for all types of metal. For simplicity, we tend to categorize all metals into three types:

- **Ferrous:**
Any metal that can easily be attracted to a magnet (Steel, iron, etc.).

Typically the easiest metal to detect and usually the most common contaminant.

- **Non-Ferrous:**
Highly conductive non-magnetic metals (copper, aluminum, brass, etc.)

When inspecting dry products these metals produce almost the same signal size as ferrous due to the fact that they are good conductors.

When inspecting wet products, de-rate the sphere size by at least 50%.

- **Non-Magnetic Stainless Steel:**
High quality 300 series stainless steels (Type 304, 316).

These are always the most difficult metals to detect due to their poor electrical conductive qualities and by definition are have low magnetic permeability.

When inspecting dry products a stainless sphere will have to be 50% larger than a ferrous sphere to produce the same signal size.

When inspecting wet products a stainless sphere would have to be 200 to 300 % larger than a ferrous sphere to produce the same signal size.

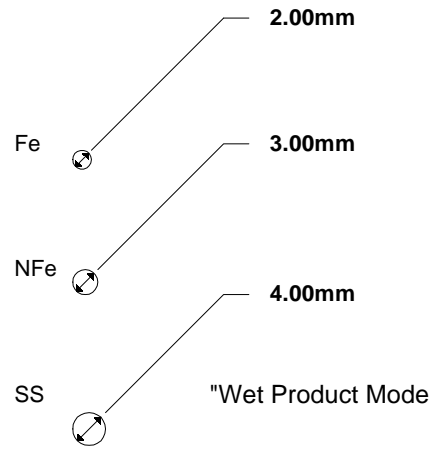
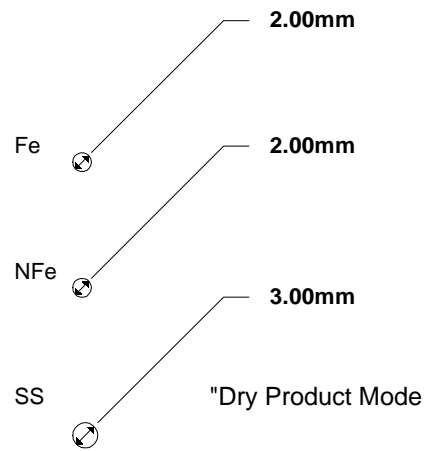

Example of Ratios ONLY

Figure 8

1.6 Shapes & Orientation of Metal

Metal detection standards are measured in spheres because a sphere is the same shape from any aspect. Real contaminants are rarely spherical and may produce a different signal depending on its orientation when it passes through the detector. The most dramatic example of this is shown by wire contaminants.

With wire shapes, the signal produced will vary greatly depending on the type of metal and its orientation as it passes through the aperture (see figure 9). In the worst case a wire may produce a signal no bigger than a sphere of the same size as the diameter of the wire.

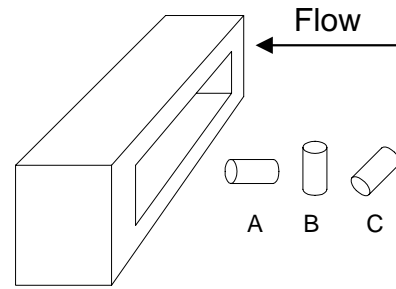

Figure 9

In Figure 9:

Ferrous Wires:

- **A** – Easiest position, biggest signal.
- **B, C** – Hardest Position, smallest signal.

Non-Ferrous and Stainless Steel Wires:

- **B, C** – Easiest position, biggest signal.
- **A** – Hardest position, smallest signal.

2. Testing Metal Detectors

Regardless of how sophisticated or reliable a metal detection system may be, it is essential that a frequent and thorough test and recording program be established. This is an essential component if any quality or HACCP (Hazard Analysis & Critical Control Points) system. In the absence of any industry standards for detector testing each company must establish their own test criteria. To date many of the standards adopted have been defined by the major retailers

The following points should be considered when developing or changing your program:

2.1 Test Sample

Historically, metal detectors have been tested with a ferrous and non-ferrous, and sometimes a stainless steel test sample.

More recently there has been a trend towards using a single, (preferably stainless steel), test sample in order to simplify the test process.

The size of the test sample must be established so that it can be reliably detected inside the product passing through the centerline of the detector - least sensitive point.

Every application will be different and therefore the samples should be tailored to each detector. If the sample is too small for the application, it will cause unnecessary test failures and create a high frustration level with the test operators. If the sample is too large, it will not accurately test the performance of the detector. Using a selection of test sample sizes, establish a realistic and repeatable operating performance level. Then a detectable test sample(s) can be chosen.

Typical guidelines for sensitivity:

Aperture Height	Dry Product		Wet Product	
	Ferrous & Non Ferrous	Ferrous	Non Ferrous	
Up to 50mm	1 mm	1.5mm	2.mm	
Up to 125 mm	1.5mm	2 mm	2.5mm	
Up to 200 mm	2 mm	2.5mm	3.mm	

2.2 Test Frequency

The company management must decide the frequency of testing the detector. Typically, detectors are tested:

- Shift Change
- Product Change
- Hourly

There is an obvious tradeoff between the cost of testing versus the risk of potential detector failure. The use of an automatic test system can increase the frequency of detector performance testing at no additional cost.

2.3 Test Procedure

The procedure itself should be kept as simple as possible, but must take into account the following:

- a) The test sample should travel through the approximate centerline of the aperture which is the least sensitive point.
- b) The test samples should be placed within the product if possible.
- c) The test procedure must allow the reject device to activate so that the entire system is tested.
This can include :-
 - Testing with contaminant at leading and trailing edge
 - Testing successive packs
 - Testing alternate packs
- d) The results of the test must be recorded.

2.4 Test Records

A sample of a test record is included for information.

The format is not important, however it should include:

- a) Line or detector identification
- b) A date and time
- c) The sample used
- d) Identification of the operator
- e) A pass or fail result
- f) A corrective action taken if result was a failure

2.5 Automatic Test Systems

There are some Automatic Testing systems designed to complement, and in some applications replace, manual test procedures. The capability of these systems should be reviewed carefully to ensure that the testing is relevant and feasible for the application. No doubt when installed effectively they can offer considerable savings through reduced labour and material wastage.

3. SOURCES OF INTERFERENCE

Environmental conditions may effect the performance of the Metal Detector, particularly where high levels of sensitivity are to be achieved. Where ever possible the detector should be positioned to avoid or minimise the effect from such conditions.

These can be generated by a number of sources:-

- Airbourne electrical interference - static, radio, earth loops
- Vibration - moving metal
- Temperature fluctuation - ovens, freezing tunnels

Whilst the detector may be capable of filtering some of this interference out, through such features as "Automatic Balance", in many cases the only option is to reduce the sensitivity level.

This is an important consideration to be taken into account when comparing the capabilities of detectors.

4. APPLICATIONS

4.1 Conveyor Systems - End of Line

End of line metal detection is generally the preferred option, as at this point product has been packaged and there is no further risk of contaminants.

For a number of reasons, as defined above, this is not always feasible.

- Physical restrictions - no space available
- Package type/material - foil lids or trays
- Package Size - too large for detection standard
- Critical points - machinery protection or raw ingredients

4.1.1 Design Issues

Basic purpose of a conveyor system is to move product through the detector and successfully reject contaminated product. In order that the optimum performance is achieved from the system there are a number of design issues which should be taken into consideration.

Detector Performance

Manufacturers will generally supply recommendations for achieving the best performance from the metal detector - they should always be applied.

- Isolated Rollers - prevent ground loops
- High quality Belt - metal free, interlocked finger join, plastic modular belt
- Low vibration and Static
- Adequate metal free area

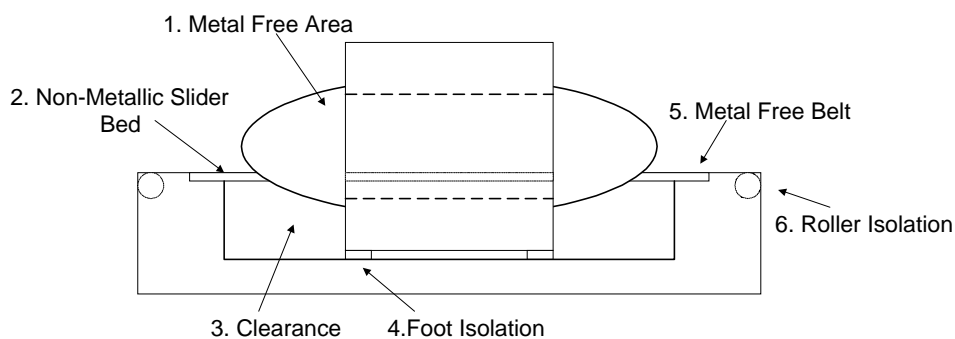

Reliable Reject

The selected reject device must be suitable for:

- Pack - size, weight & shape
- Presentation - pitch, line speed and belt width

The following table gives a general guideline to which design will be best suited to your application. The figures may vary slightly with manufacturer.

<u>Type</u>	<u>Suited for</u>	<u>Max. Wt</u>	<u>Notes</u>
Air Blast	Light consumer packs i.e biscuits, chocolate bars. High throughput	1 kg	Unsuitable for loose product, boxes curved surfaces and some bagged product
Diverter Arm	Medium to light packs. Medium throughput	5 kg	Product generally enters bin diagonally - must ensure it will fit !
Pusher/Ram	Medium packs High throughput	7 kg	Unsuitable for loose or fragile product
Stop on Detect	Large bags or boxes, hand fed or bulk material. Slow throughput	25 kg	Requires an operator to contaminated product
Retracting Band/Carriage	Small product in lines or of irregular shape. Medium throughput.	2 kg	Dimensions are for whole line or batch of products

The following additions are also recommended to ensure reliable rejection of contaminated product.

- Registration photo eye - to ensure correct timing
- Enclosed area from detector to reject - to avoid pack removal
- Lockable bin - ensure contaminated packs are quarantined

4.1.2 Testing

In addition to ensuring the metal detector is functioning correctly, the complete system functionality should be checked as part of the procedure.

This basically involves ensuring that the reject device is operating correctly and contaminated product is correctly handled.

This is generally proved by the following methods:

- Placing the test piece at the leading edge of the product
- Placing the test piece at the trailing edge of the product
- Passing successive test packs
- Passing alternate test packs

For all the above the system should be observed to ensure that the reject system operates correctly.

4.1.3 Other Considerations

In addition to regular manual testing additional fail safe methods can be incorporated into the system design.

- Reject confirmation / Bin Full sensors
- Air Pressure Failure
- Fault / Shut down

4.2 Drop Through / Gravity Metal Detector

On the surface, the drop through application of metal detector is very simple. However, care must be taken in the initial design to avoid having to make major modifications after installation. Please consider all the following steps when designing a drop through detection system.

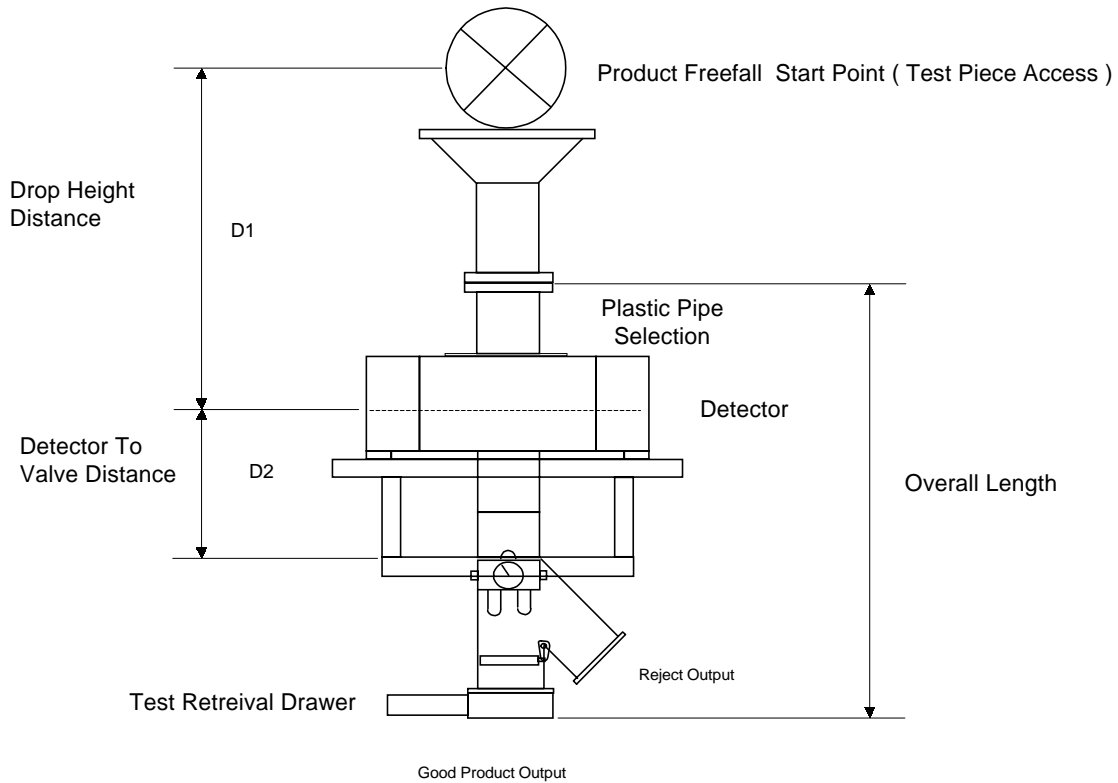

4.2.1 Design Issues

A gravity detection system is ideally suited to inspecting dry, free flowing products such as:

- Grains, flours, cereals
- Rice, nuts, sugar
- Plastic pellets and flakes

The product must remain free flowing and never back up into any part of the system.

Determine Pipe Internal Dimension

Often the existing piping will determine the pipe and detector size, or use the following formula based on knowing the peak expected flow rate of the product and its bulk density.

$$\text{Area of throat required (inches square)} = \frac{0.024 \times \text{FLOW RATE (\#/hr)}}{\text{BULK DENSITY (\#cu.ft.)}}$$

Metal Detector Basics

Example: A product with a flow rate of 30,000 pounds / hour, and a bulk density of 40 pounds / cubic foot will require a calculated pipe area of $0.024 \times 30,000 / 40 = 18$ square inches.

Round Versus Rectangular Pipes

A round pipe will utilize the pipe area required for product flow more efficiently than a square or rectangular pipe, and therefore the flow capacity of rectangular pipes should be de-rated by at least 20%.

A rectangular system may sometimes have an advantage of allowing a shorter overall length due to the shorter stroke and reaction time of the valve (see below).

System Overall Length

Once the proper pipe size has been established, the overall system length can be considered. The bigger the pipe I.D. (or smaller dimension of a rectangular system) the longer the system must become. The detector through dimension must increase as aperture size increases, the valve height will also increase due to the increased stroke, and the required distance between the valve and the detector must increase. The latter is due to the larger valve taking more time to reach full divert position and therefore it must be located further from the detector.

It is very important to consider the relationship between valve response time and, product free fall height, and system length.

In order to properly design the system, the following must be known.

- product pipe size (from above)
- valve response time (from manufacturer-bigger valves require more time)
- product free fall distance from initial drop to the centerline of the detector (D1 - see diagram).

If the free fall height is increased, the distance between the detector and valve must be increased in order to maintain adequate time for the valve to respond.

Due to the fact that the product is accelerating as it falls at 32ft/sec squared, small changes in the detector to valve distance will have a drastic effect on the maximum allowable free-fall distance.

For example, given a valve response time of 50ms and a detector to valve distance of 8", the calculated maximum free-fall would be 29". If the valve were moved 2" closer to the detector (to 6"), the maximum free-fall would now be only 16".

4.2.2 Testing

One of the not so obvious drawbacks with a drop through detector system is that it is very difficult to test. However, if testing access and recovery is designed into the system, then testing can be done quickly and reliably. It is important to recognize that the testing procedure must confirm the detectors' performance as well as the response of the reject valve.

To achieve this, the design must incorporate:

- Test Access Port
An access port to introduce a test sample (plastic ball with metal sample imbedded) must be provided at the product free-fall origin. The test port should allow the sample to fall from the

same place that the product begins its fall, so that the test sample speed will be the same as the product.

➤ Test Sample Safety Retrieval Gate

A safety catch gate should be inserted into the normal product flow below the valve “good” product output when testing is carried out, so that the test sample can be safely recovered if the detector fails to detect the sample, or the valve fails to react properly.

In a good design, the test gate can be quickly inserted into the product flow during a test, and removed from the flow afterwards.

Automatic Testing

A manual test must be performed upon initial installation and at reasonable time intervals. However, in this application an Automatic Test system can offer considerable benefits. If correctly designed this test system can ensure that testing is both consistent and relevant.

4.2.3 Other Considerations

Static

With all falling dry powders and granules, static electricity is generated. Some products are more prone to do this more than others, and environmental conditions like humidity will also contribute to the equation.

To help reduce static damage and interference, the following measures should be considered:

- All metal near the detector system (pipes, flanges, structural supports) should be properly grounded so that large charges can not accumulate.
- Plastic parts (product tube, etc.) may need to have conductive shields wrapped around them to help dissipate large charges. However, grounding standard (non-conductive) plastics will not eliminate static. Some conductive plastics are available for food use, but may interfere with the detector.
- The detector itself should also have a major single point ground (consult the manufacturer for their recommendations). Detectors then use remote power supplies may be more susceptible to damage.
- As a last resort, an ionizing anti-static device may be considered.

With careful design and accurate information, the drop through gravity application of metal detectors can provide excellent sensitivity and early warning of product contamination concerns, but the critical parameters must be considered in the early design stages.

4.3 Pipeline Metal Detector

The pipeline application involves the installation of a non-metallic pipe section around which a metal detector inspects products travelling through the pipe. This type of application should be considered where the extra sensitivity capability of a relatively small aperture outweighs the benefit of final package inspection. This is especially true if the final packaging material contains metal, such as a canning line.

Pipe System Drawing

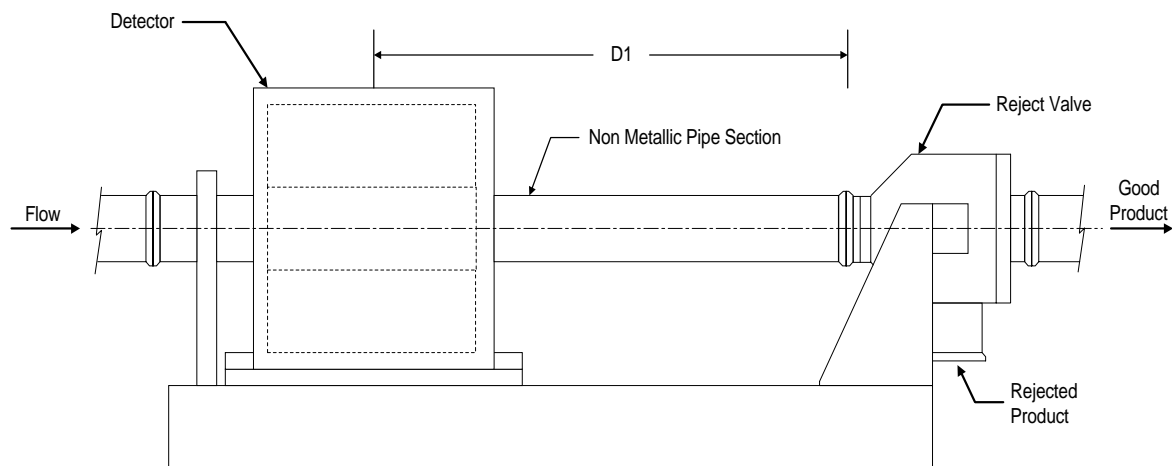

A pipeline inspection system is ideally suited to inspecting liquid, slurries or paste products that can be pumped through a pipe. Typical pipe products would include:

- sauces
- dairy products
- meat slurries
- juices etc.

4.3.1 Design Issues

The following critical factors must be known when designing a successful pipeline detection system:

- Pipe I.D.
- Pipe clamp connection style (tri-clamp, I-line etc)
- Product flow rate (GMP)
- Product viscosity
- Product temperature range
- Product pressure
- Expected cleanup procedures (wash down, pipe pig, etc.)

Determine System Length

The product speed in the pipe will determine the position of the reject valve relative to the detector. Since the valve has a minimum divert response time, the distance between the valve and the detector must be increased directly proportional to the product speed and valve response time. Product speed can be estimated given the flow rate in gallons or liters per minute. Due to laminar flow characteristics of liquids in a pipe, an appropriate safety margin must be added to the speed calculation, and the system must be rigorously tested at full production rates to ensure the valve can respond in time.

For example, given a system using a 2" pipe with a maximum flow rate of 80 gpm. The average speed of the product will be 10 feet/second. Given the response time for a 2" valve is 0.25 seconds, the valve must be at least 2.5 feet from the detector. To allow for laminar effects a 3' spacing is recommended.

Selecting The Valve Style

The choice of valve will be influenced by the product temperature and viscosity. Some valves are best suited for low viscosity products such as juices, etc. If the pipe clean out procedure includes the use of a "pig" flushed down the pipe, the valve chosen must have a straight through non-restrictive design.

Selecting The Non-Metallic Pipe

The choice of the pipe will be influenced by the style of pipe connection required, the product temperature and especially the pipe pressure expected. Care must be taken to design the installation so that the plastic pipe will not be loaded in any way by the incoming stainless steel piping.

4.3.2 Testing

One of the not so obvious drawbacks with a pipe detector system is that it is very difficult to test. However, if testing access and recovery is designed into the system, then testing can be done quickly and reliably. It is important to recognize that the testing procedure must confirm the detectors' performance as well as the response of the reject valve.

To achieve this, the design must incorporate:

- Test Access Port
An access port to introduce a test sample (plastic ball with metal sample imbedded) must be provided upstream of the detector system. The test port location should allow the sample to travel at normal speed through the detector system.
- Test Sample Safety Retrieval Gates
A safety catch gate should be inserted into the normal product flow after the valve "good" product output when testing is carried out, so that the test sample can be safely recovered if the detector fails to detect the sample, or the valve fails to react properly. It is also recommended that a similar catch gate be used on the reject output to ease the recovery of the test sample when it is rejected.

In a good design, the test gates can be quickly inserted into the product flow during a test, and removed from the flow afterwards.

Automatic Testing

As with Gravity applications, the biggest draw back of manual testing is that it is impossible to predict where the test piece will be relative to the aperture of the detector, and for the same reason test results will be inconsistent. For this reason an Automatic Test system can offer advantages.

Detectors capable of Automatic testing can be used to perform short interval testing of the detector and valve reaction without any operator involvement. The use of an automatic reject response check system is also recommended. This involves having a valve position switch feed a confirmation signal back to the detector which can then monitor the response time of the reject device during any reject occurrence.

6. Good Practice - Typical Guidelines

6.1 Prevention

- Training for maintenance and cleaning staff in metal detector basics
- Planned & controlled maintenance - possibly non production hours
- Regular inspection - for identification of potential contaminants
- Good housekeeping

6.2 Sensitivity

- Identify "standards"
- Re-evaluate standards when conditions change
- Maintain records
- Maximise sensitivity without compromising performance
- Implement security levels - passwords

6.3 Testing

- Document & communicate - who & why
- Establish frequency
- Create test packs where relevant

6.4 Rejected Product Handling

- Isolate & re-screen potentially contaminated product on test failure
- Investigate source of contaminant - trained personnel, off line & within reasonable time
- On repeat detection's identify source of contaminant
- On multiple detection's stop production

6.5 Record Keeping

- Commissioning & sensitivity details
- Test results
- Shift results - number of rejects
- Maintenance schedules
- Training